

# ELORA

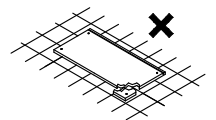

## R-1

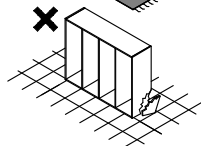

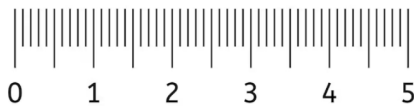
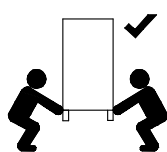
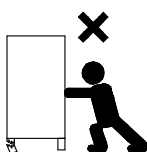
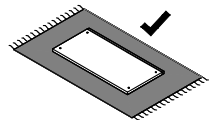
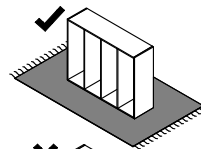
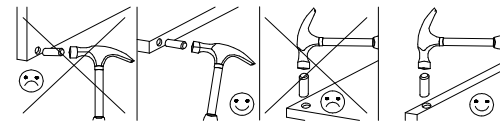
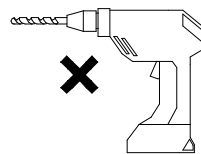
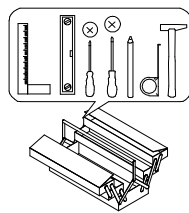
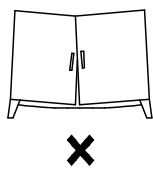
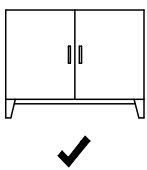
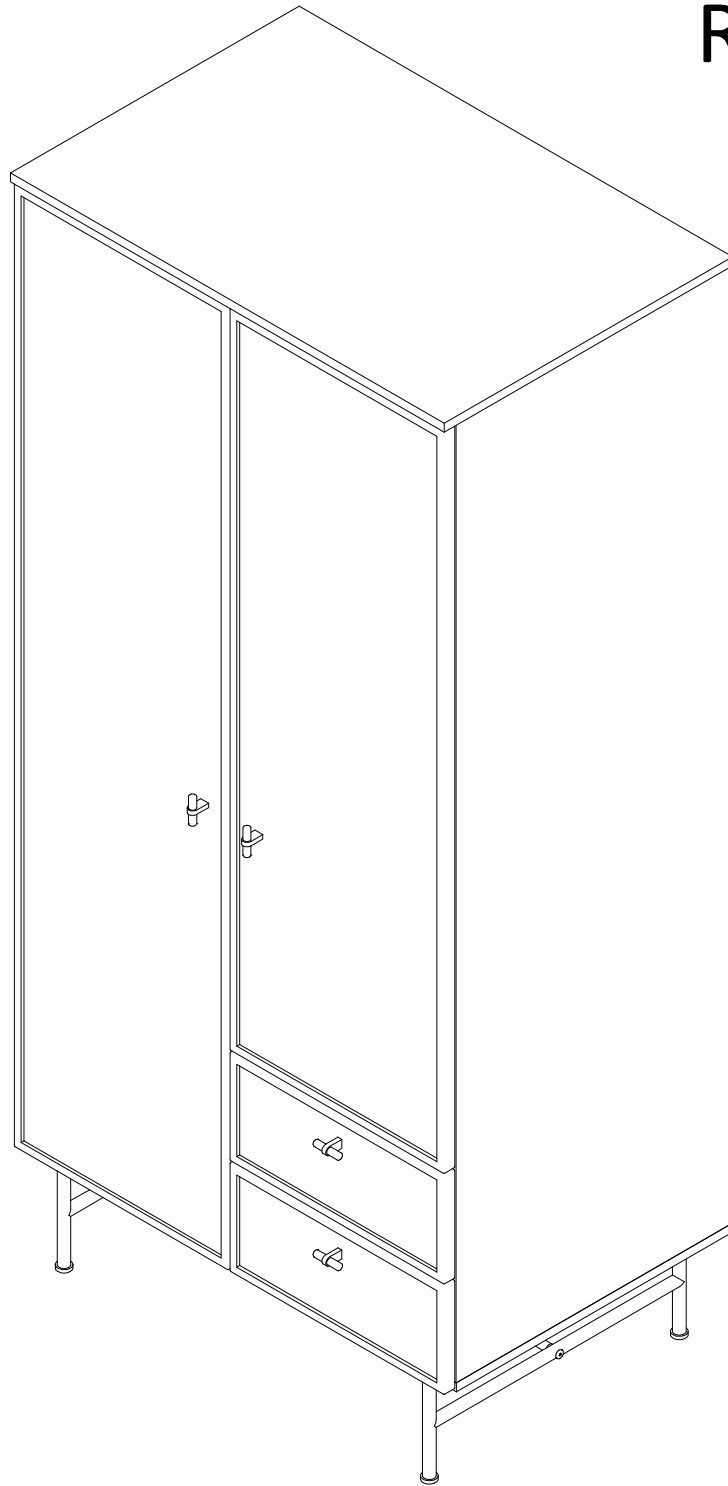

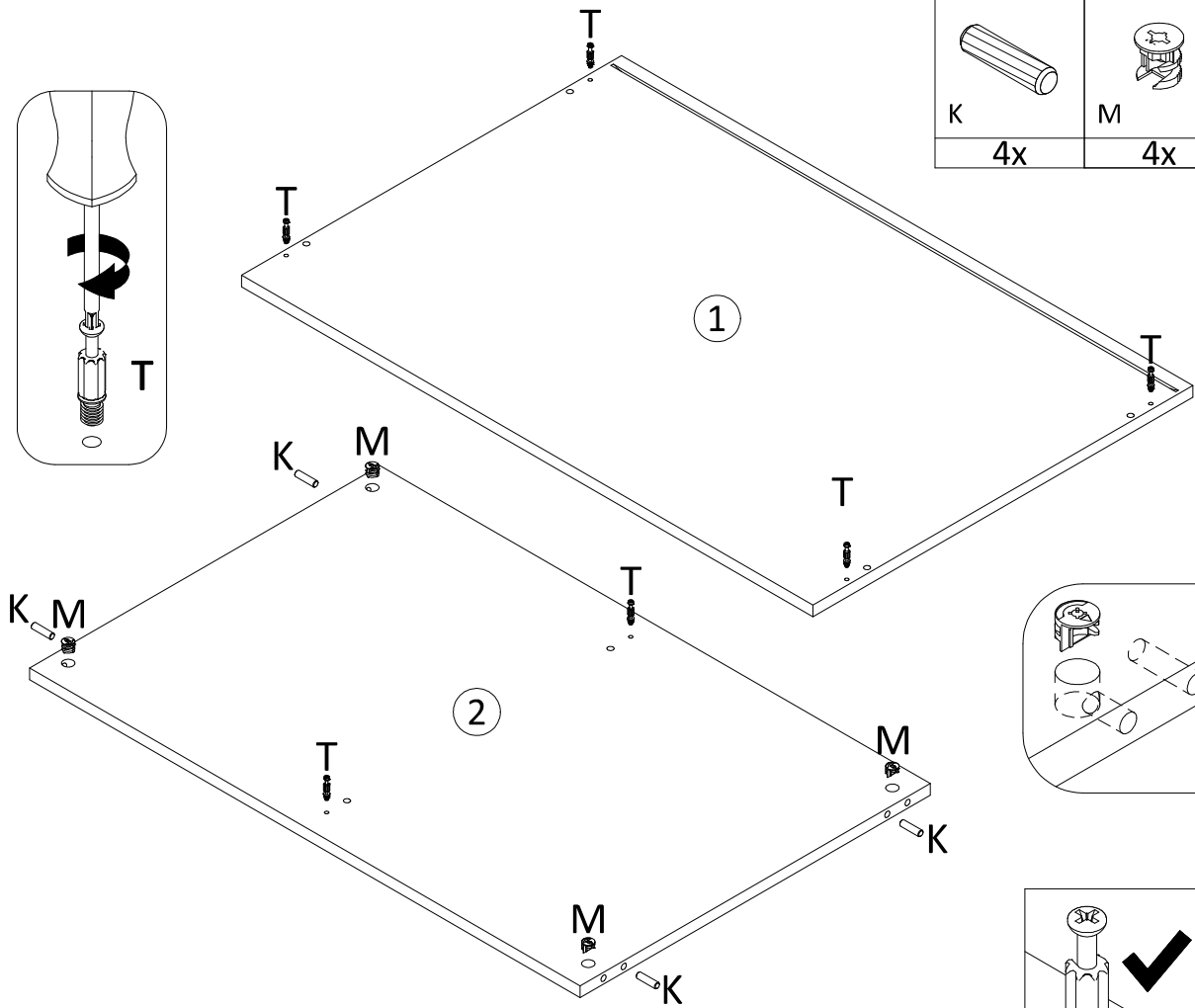
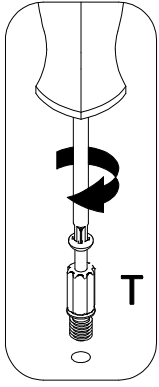
# 1

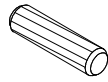

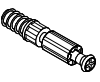

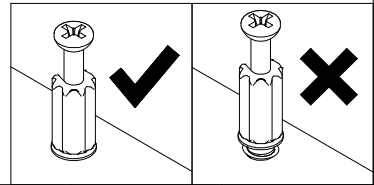
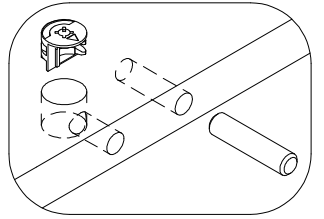
		
K	M	T
4x	4x	6x

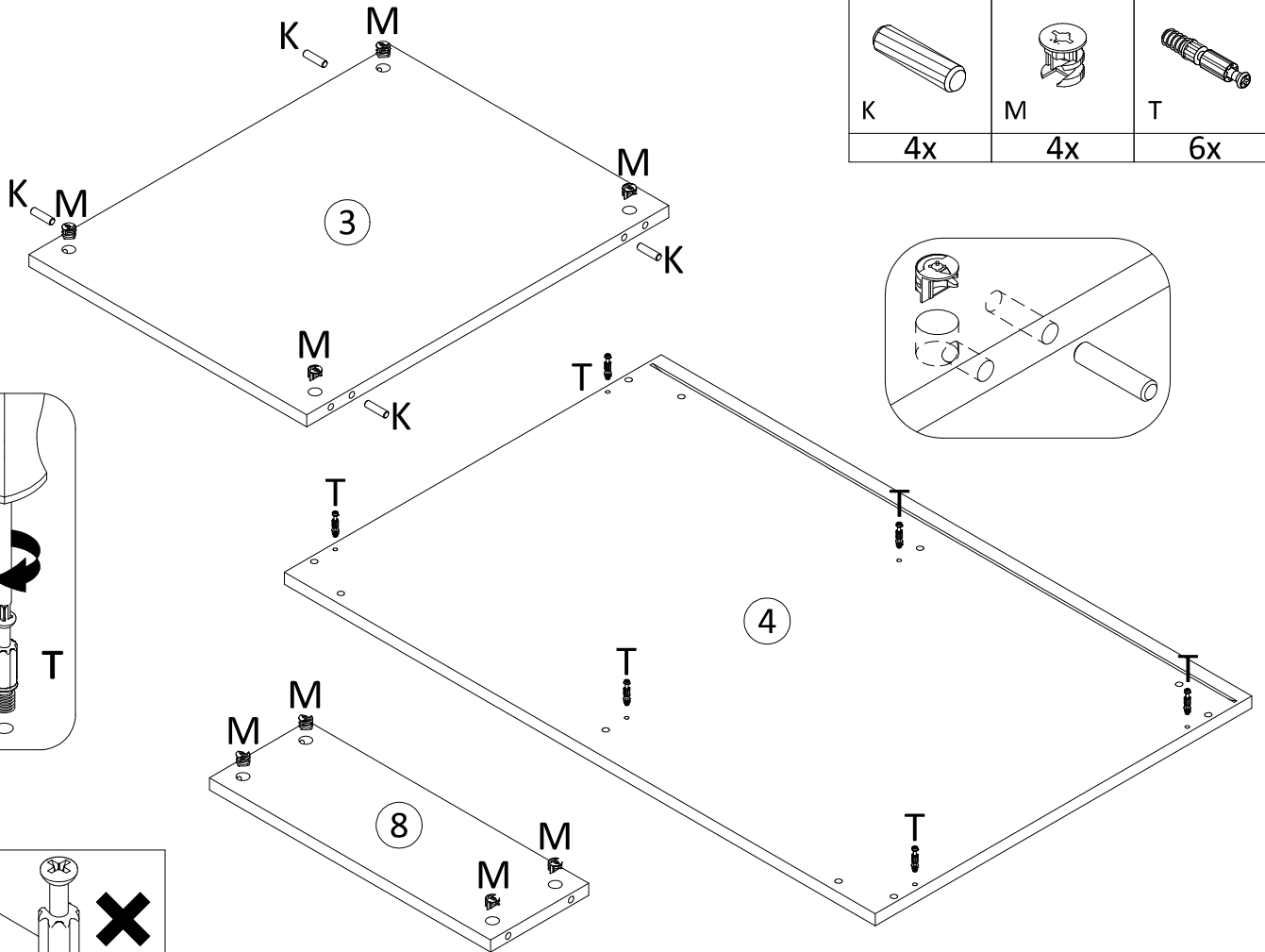
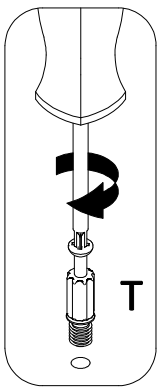

# 2

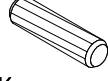

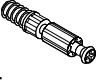

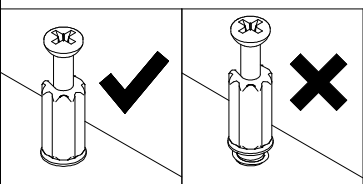
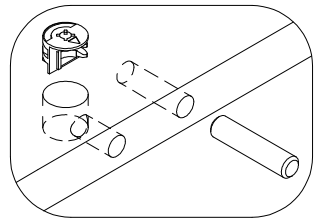

		
K	M	T
4x	4x	6x



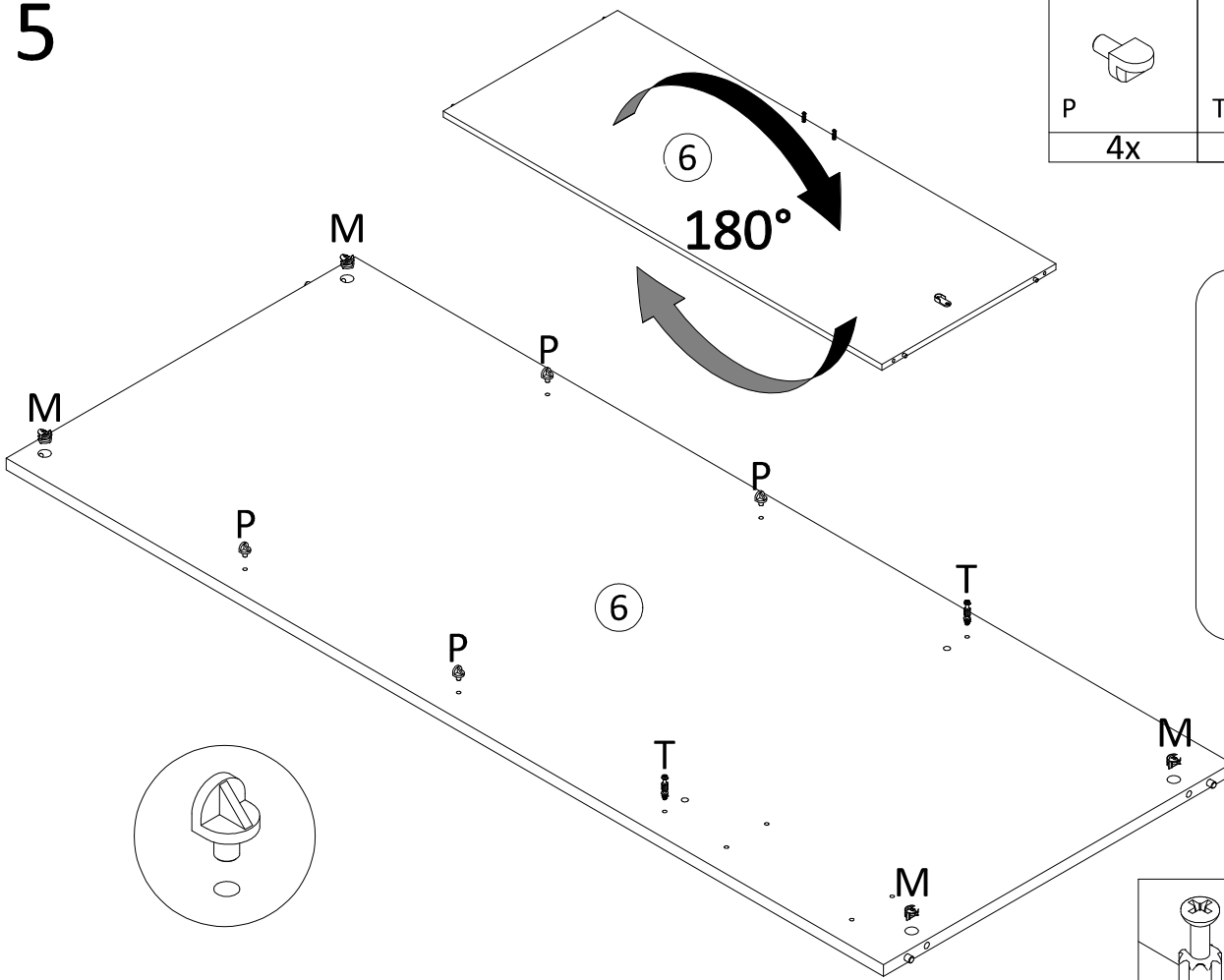

5

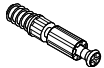

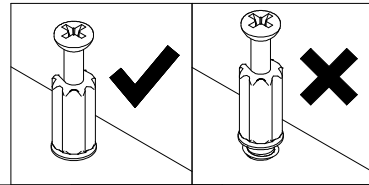
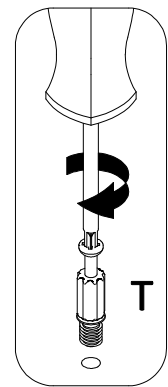

		
P	T	M
4x	2x	4x

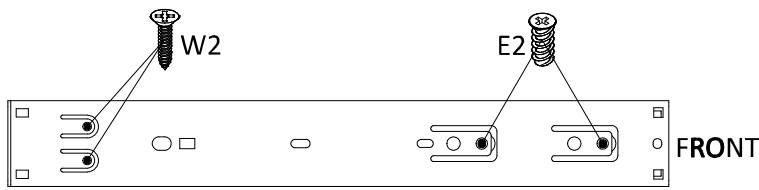

6



	
W2	E2
4x	4x

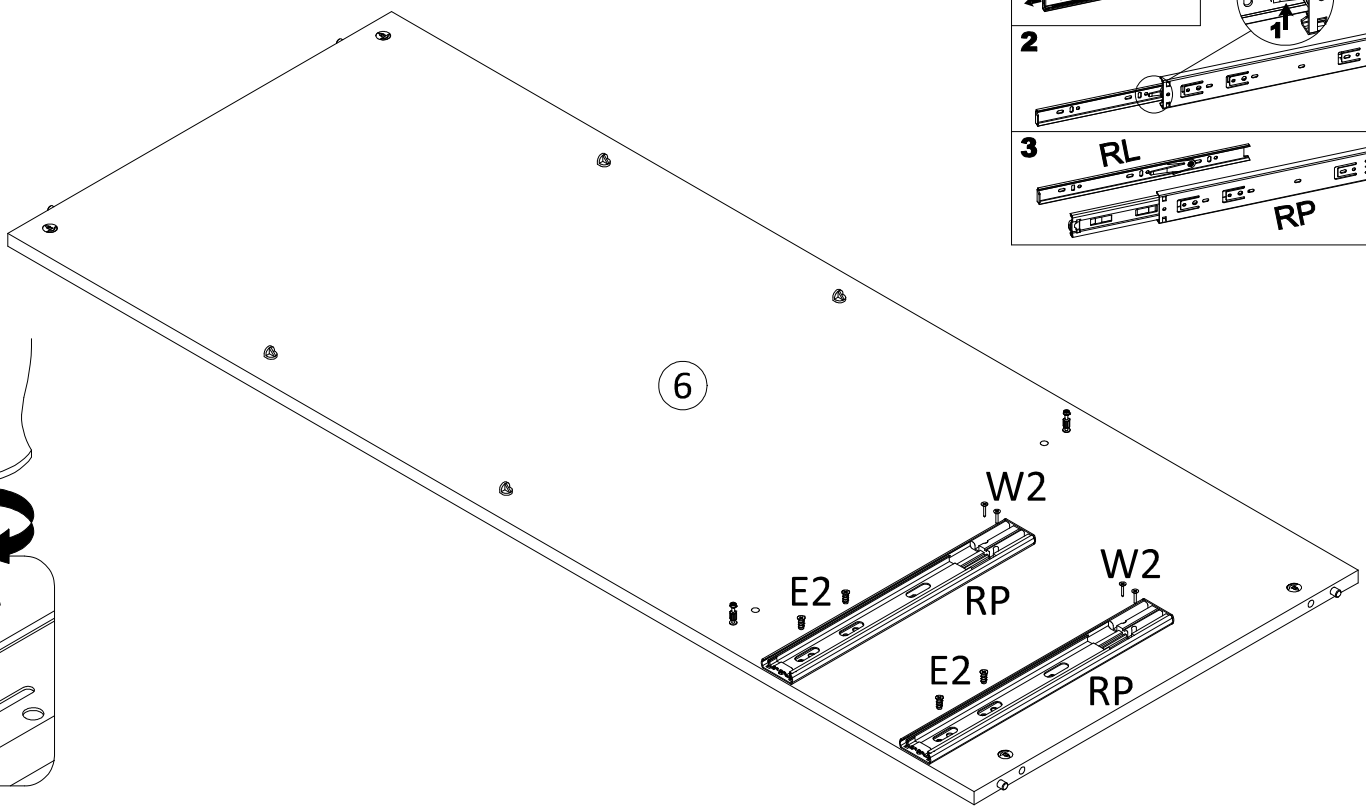
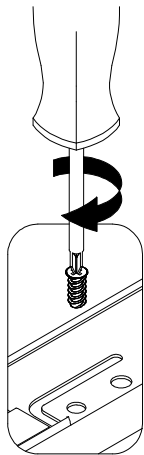
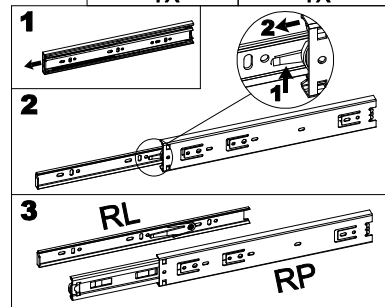



9

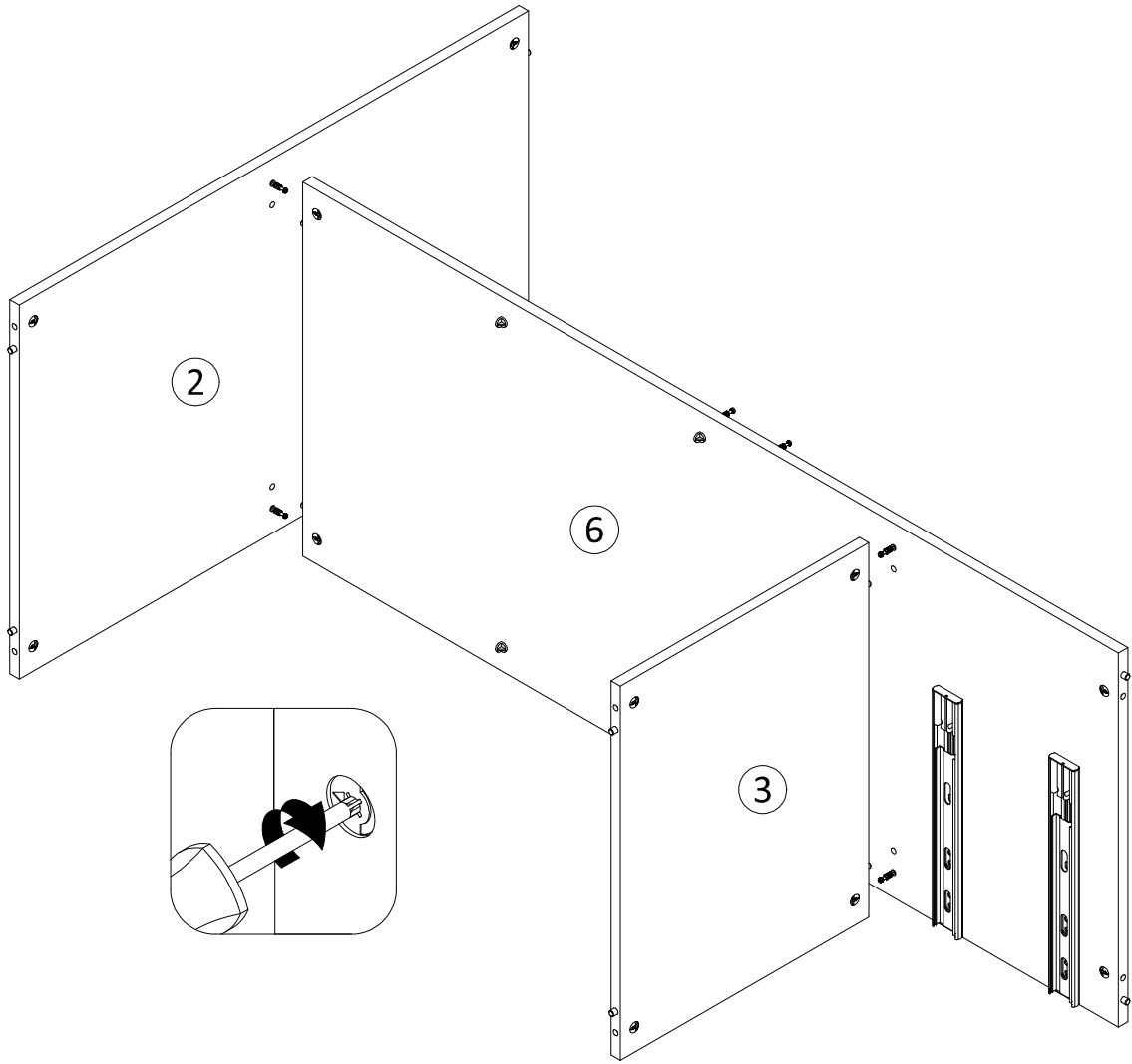

10

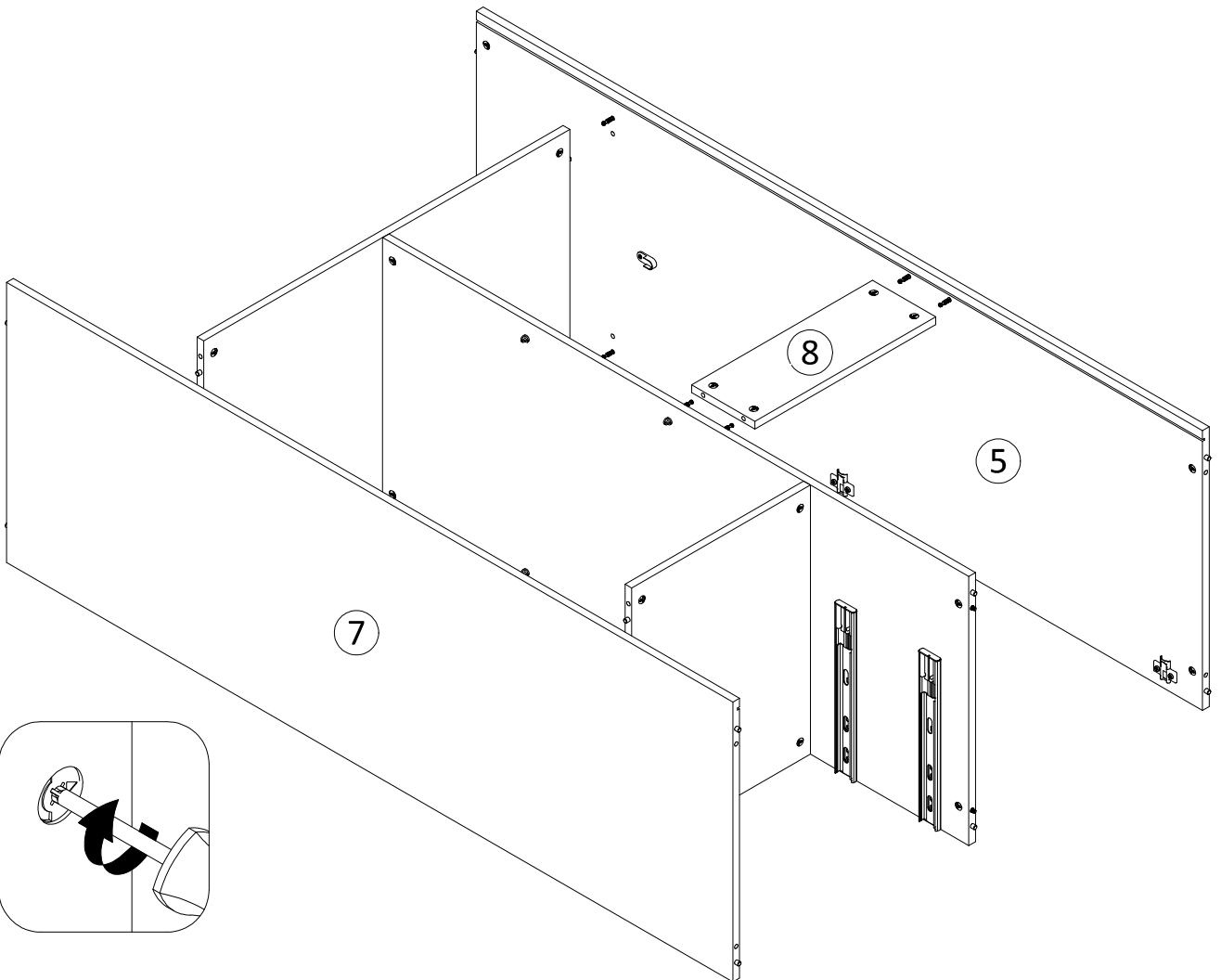

11

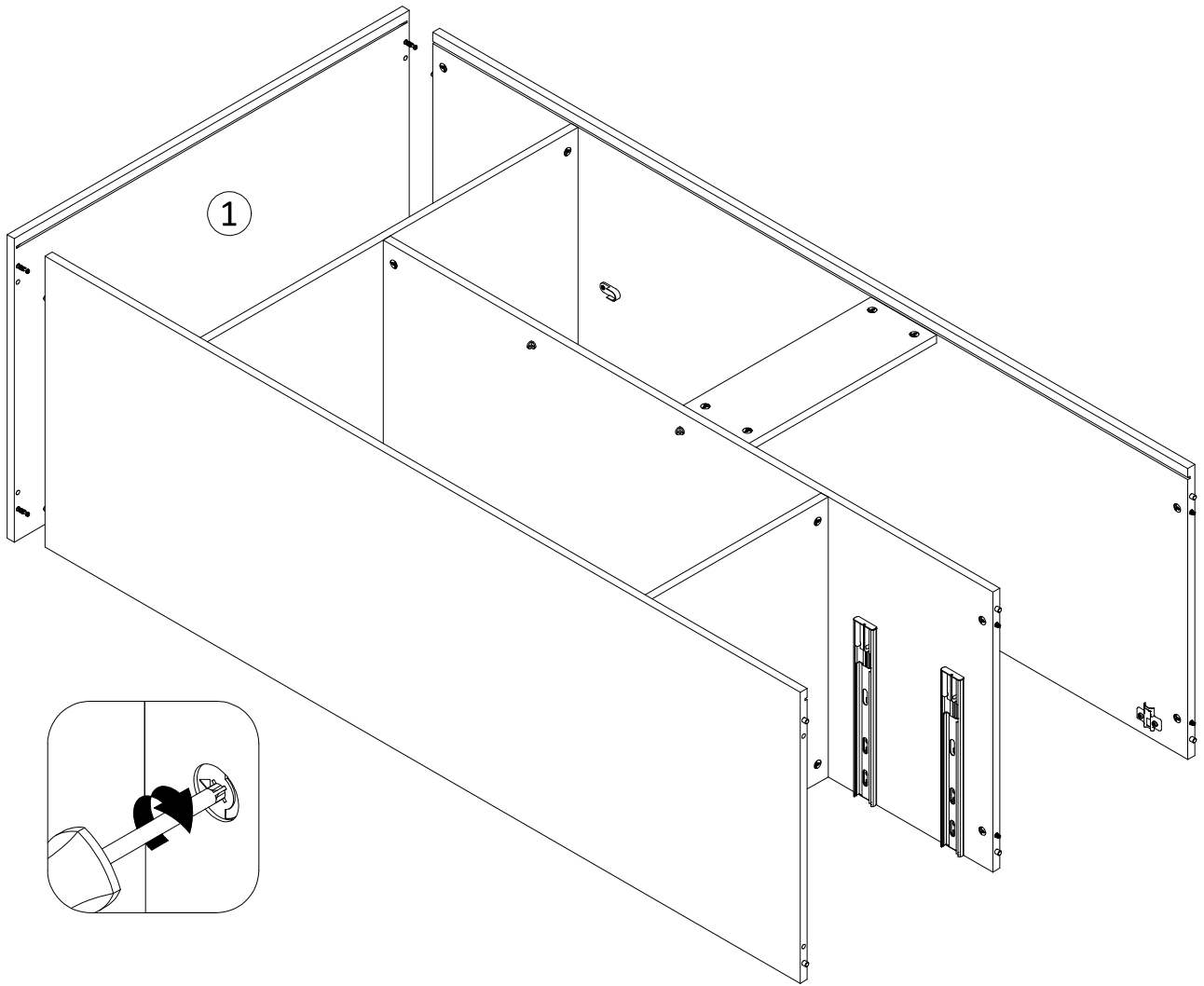



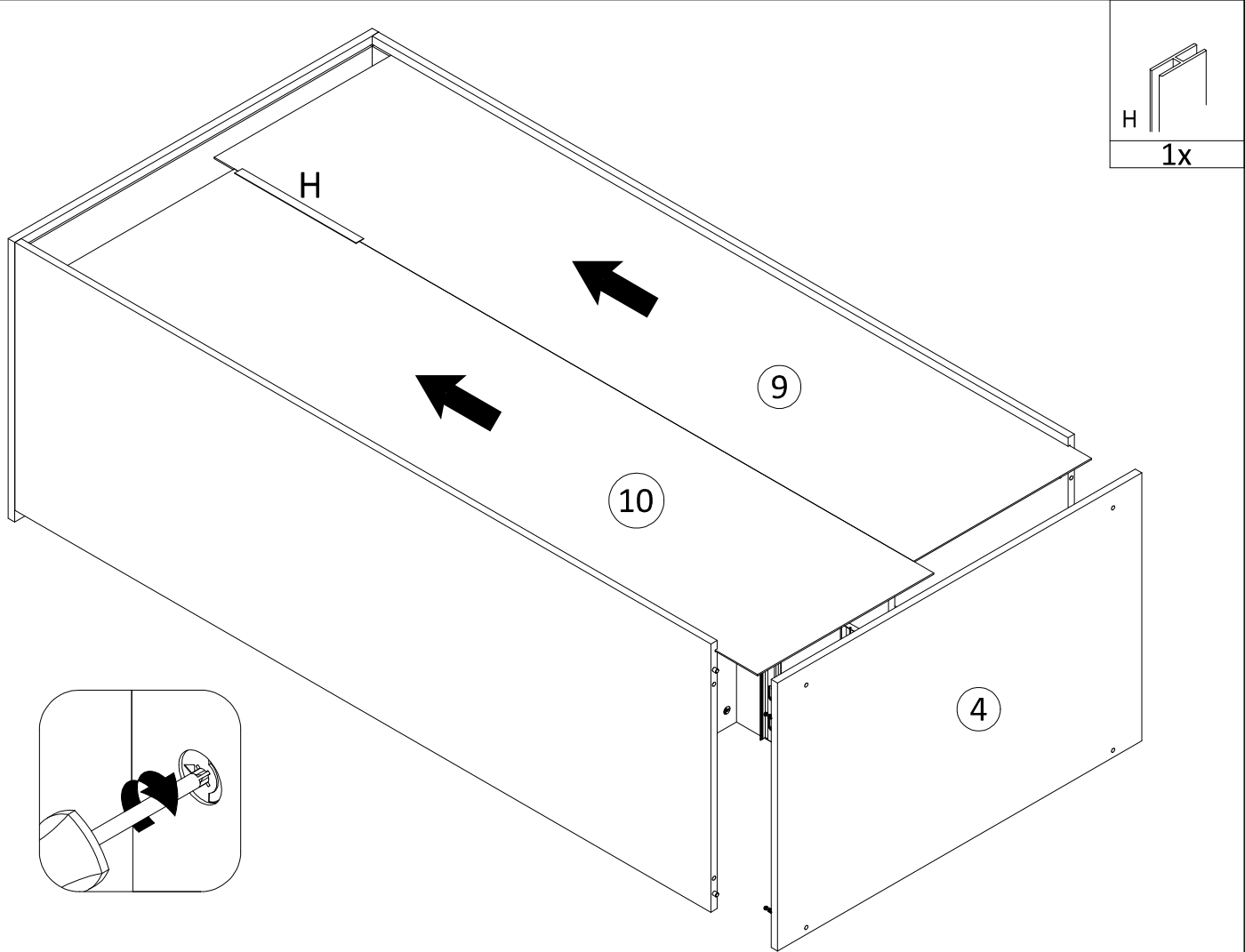

12

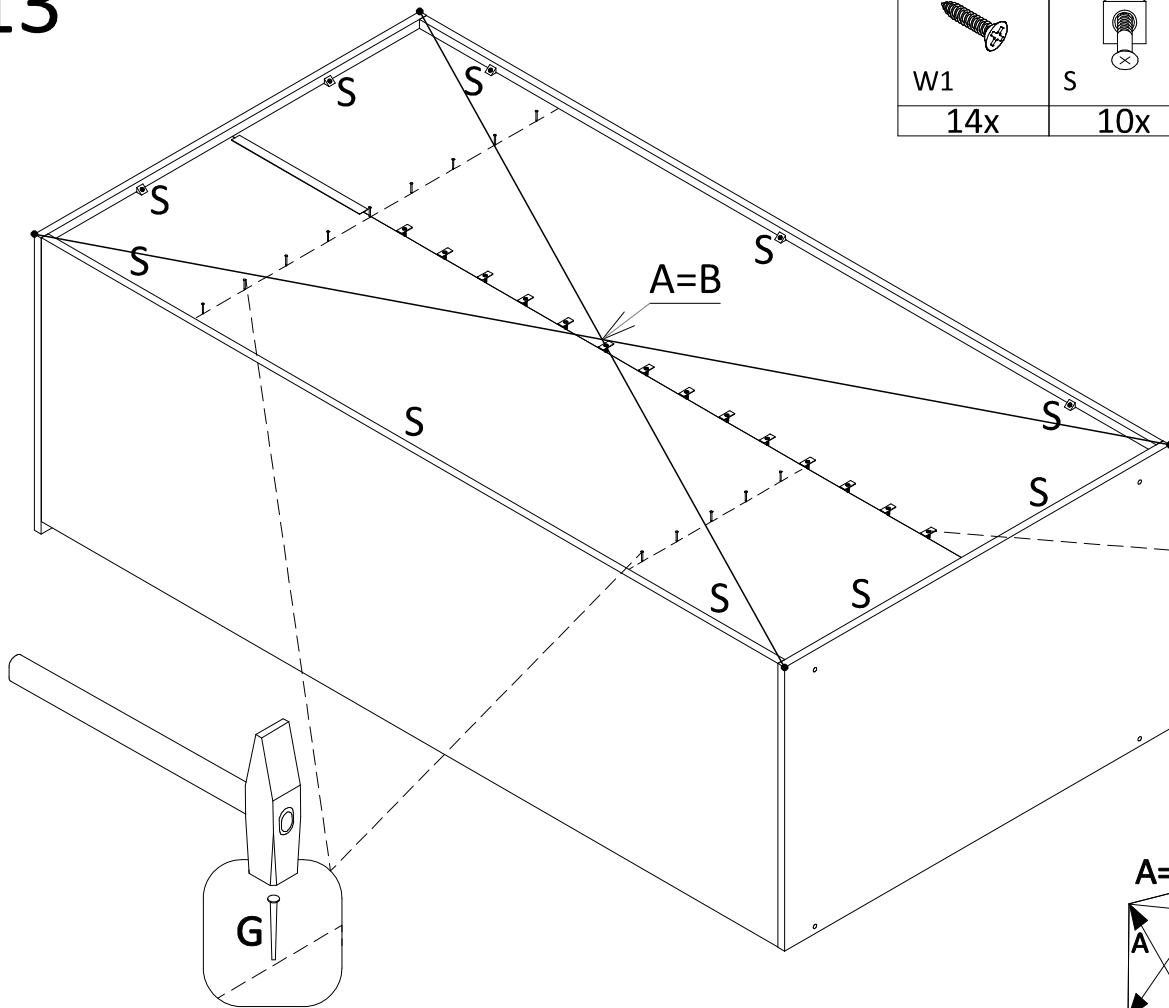

# 13



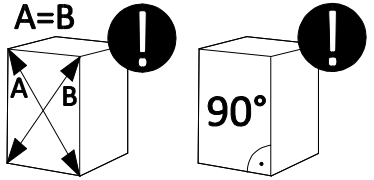
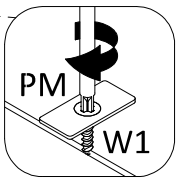
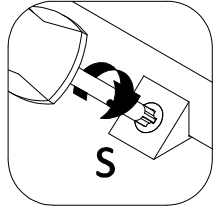

			
W1	S	PM	G
14x	10x	14x	14x

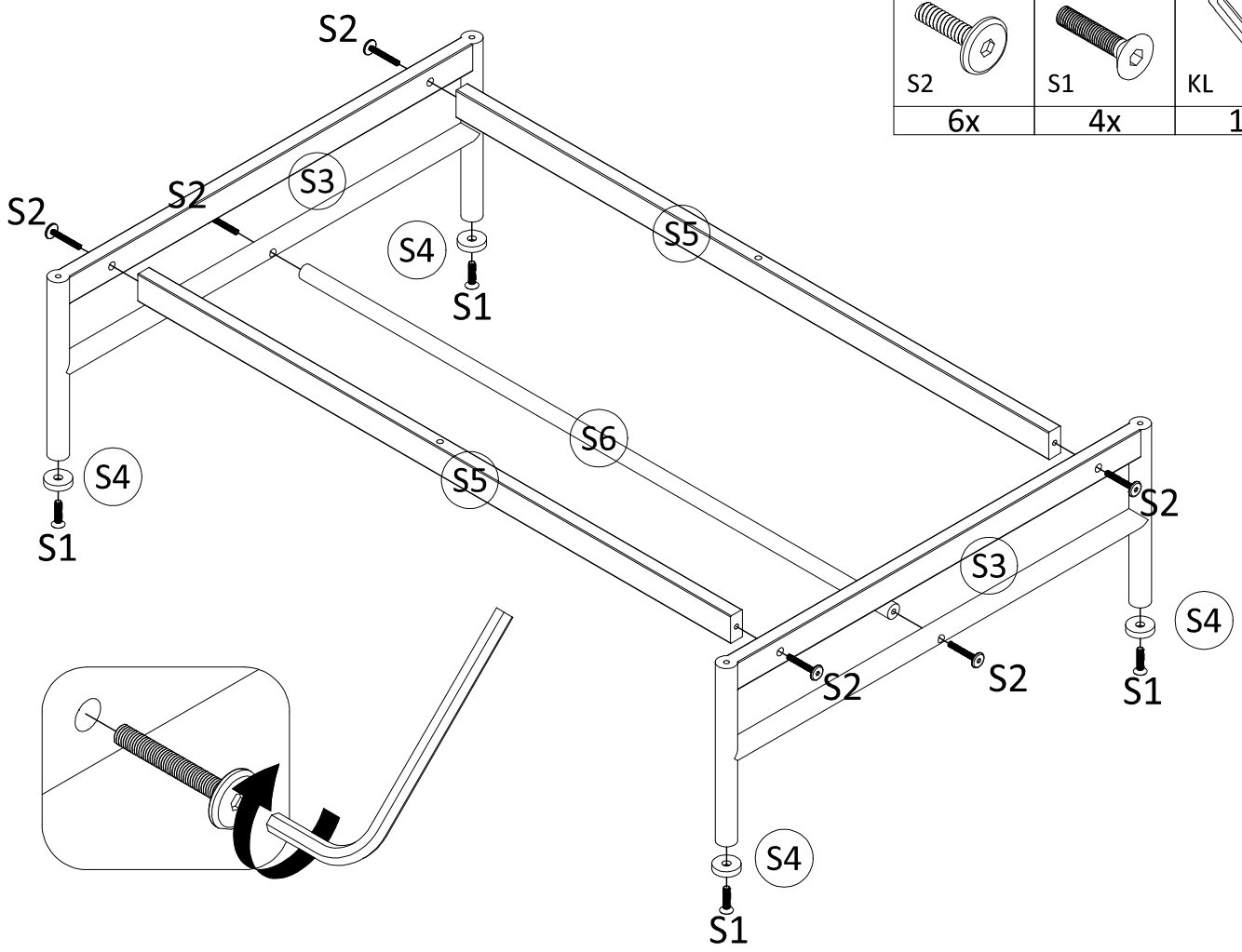

# 14

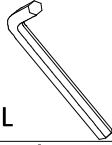

		
S2	S1	KL
6x	4x	1x

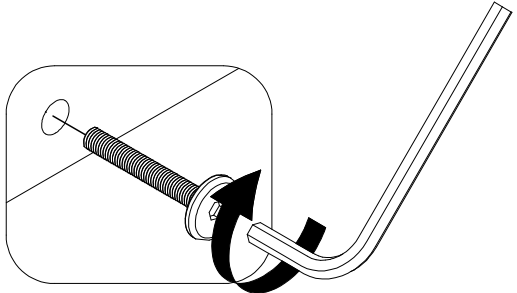

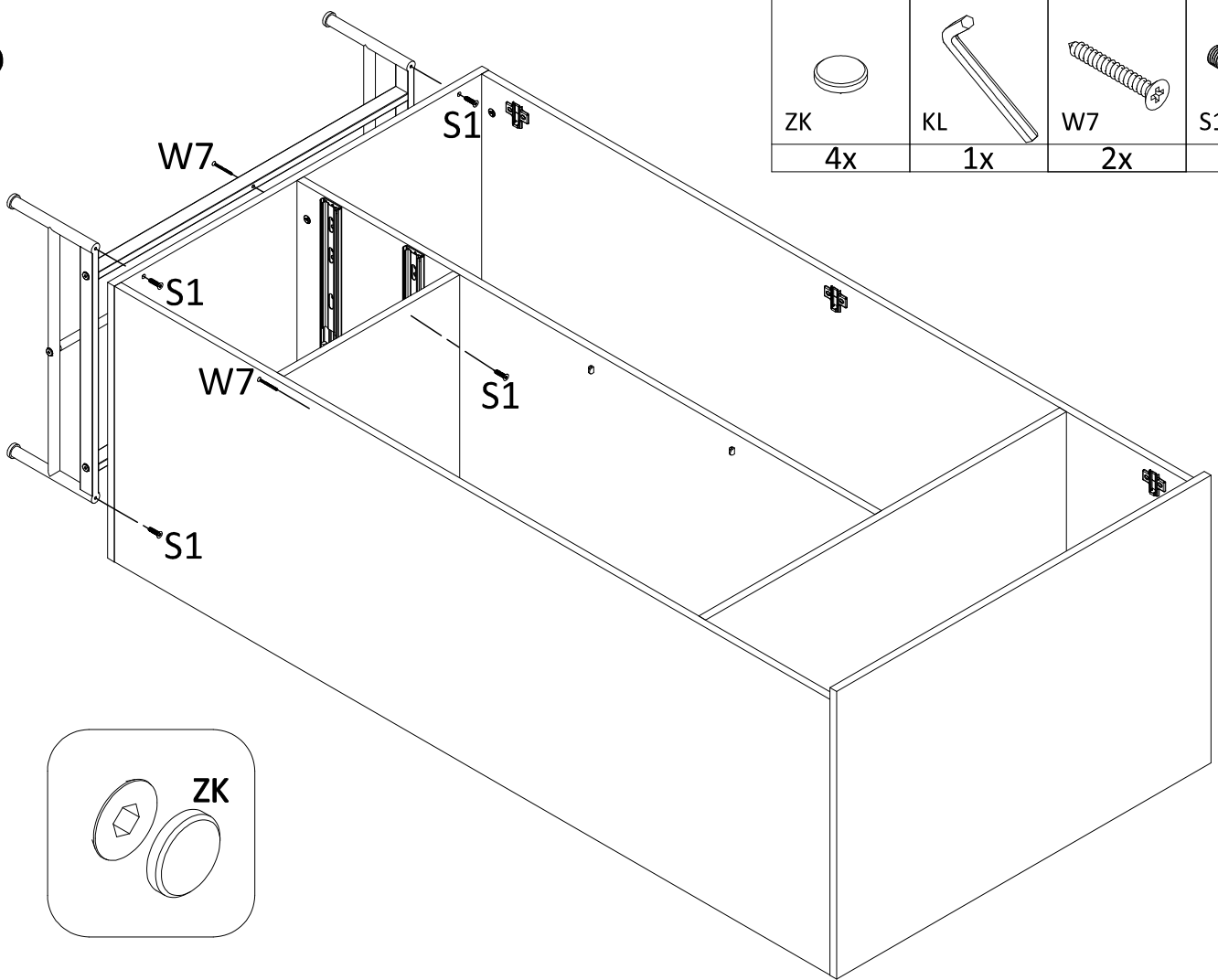

# 15

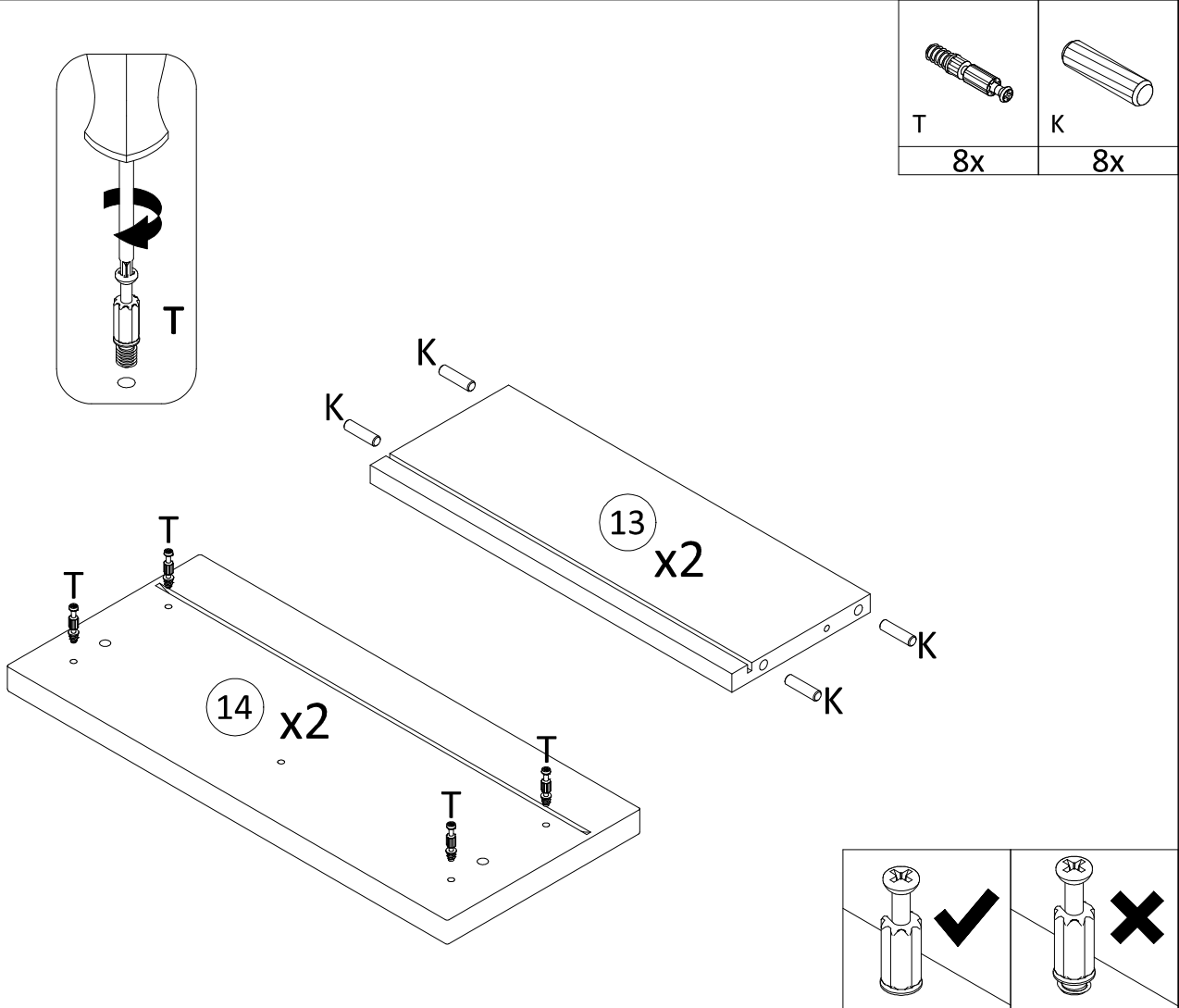

# 16

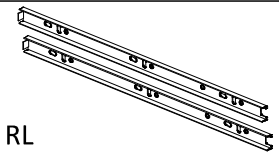

# 17

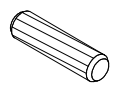
			
RL	E1	M	K
2x	8x	8x	4x

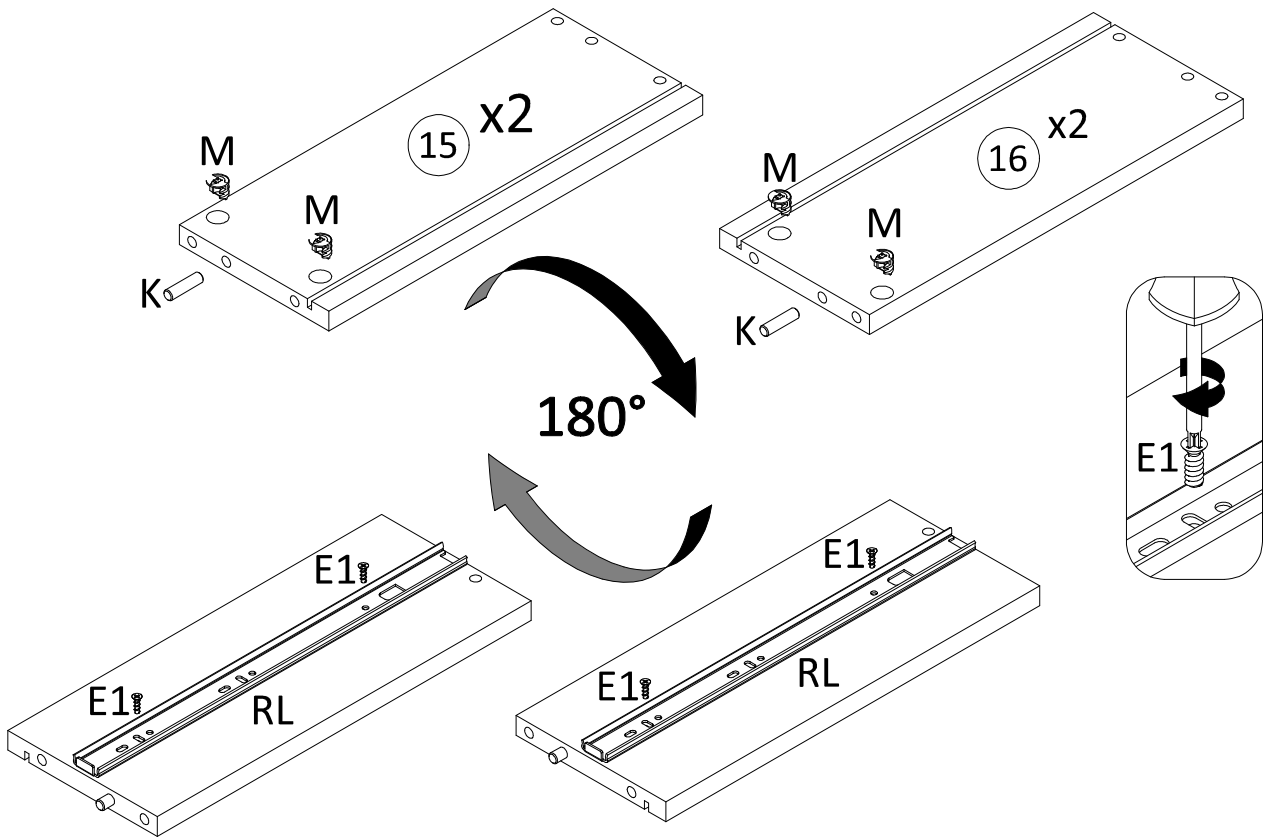

# 18

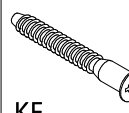
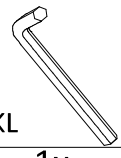
	
KF	KL
4x	1x

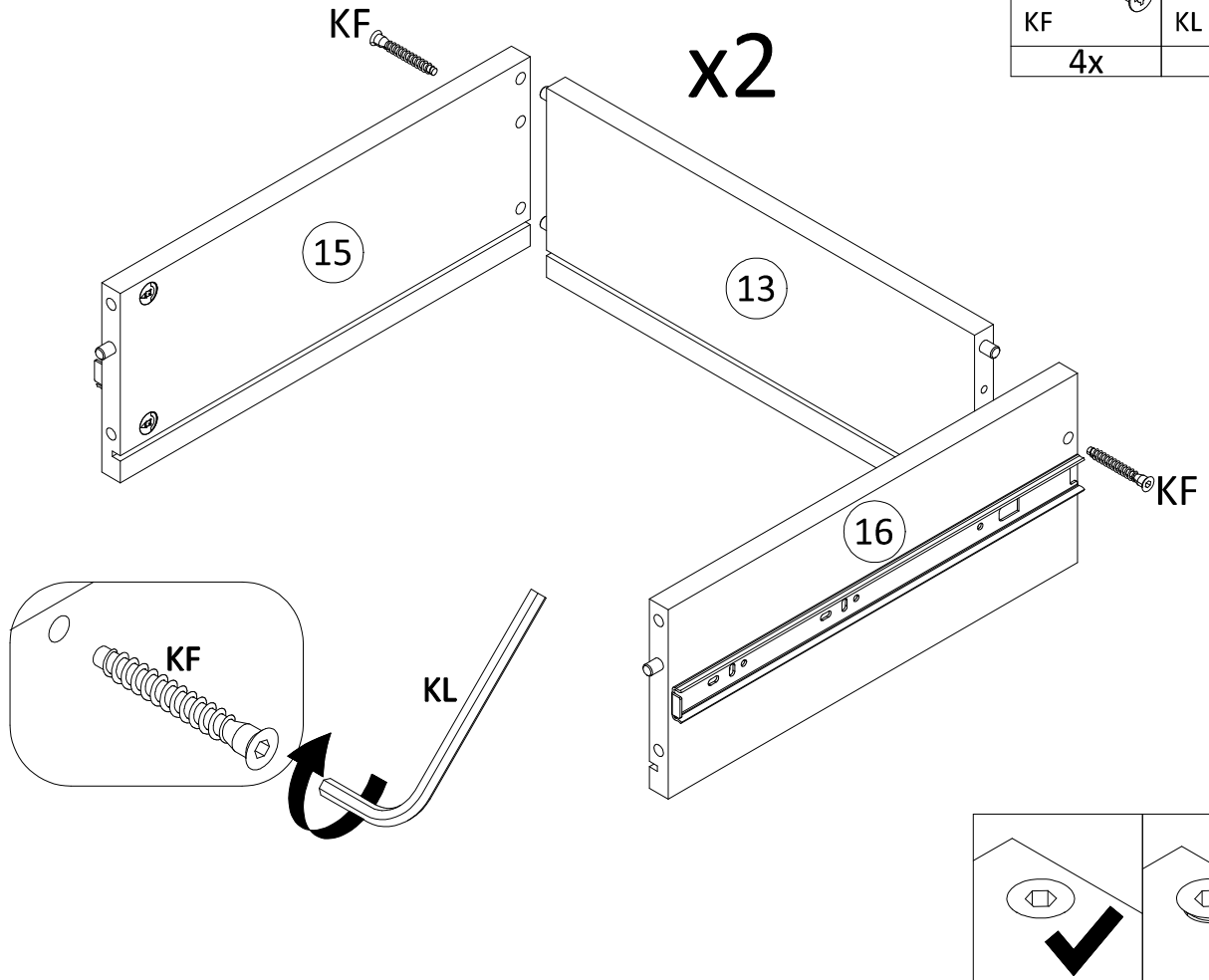

19

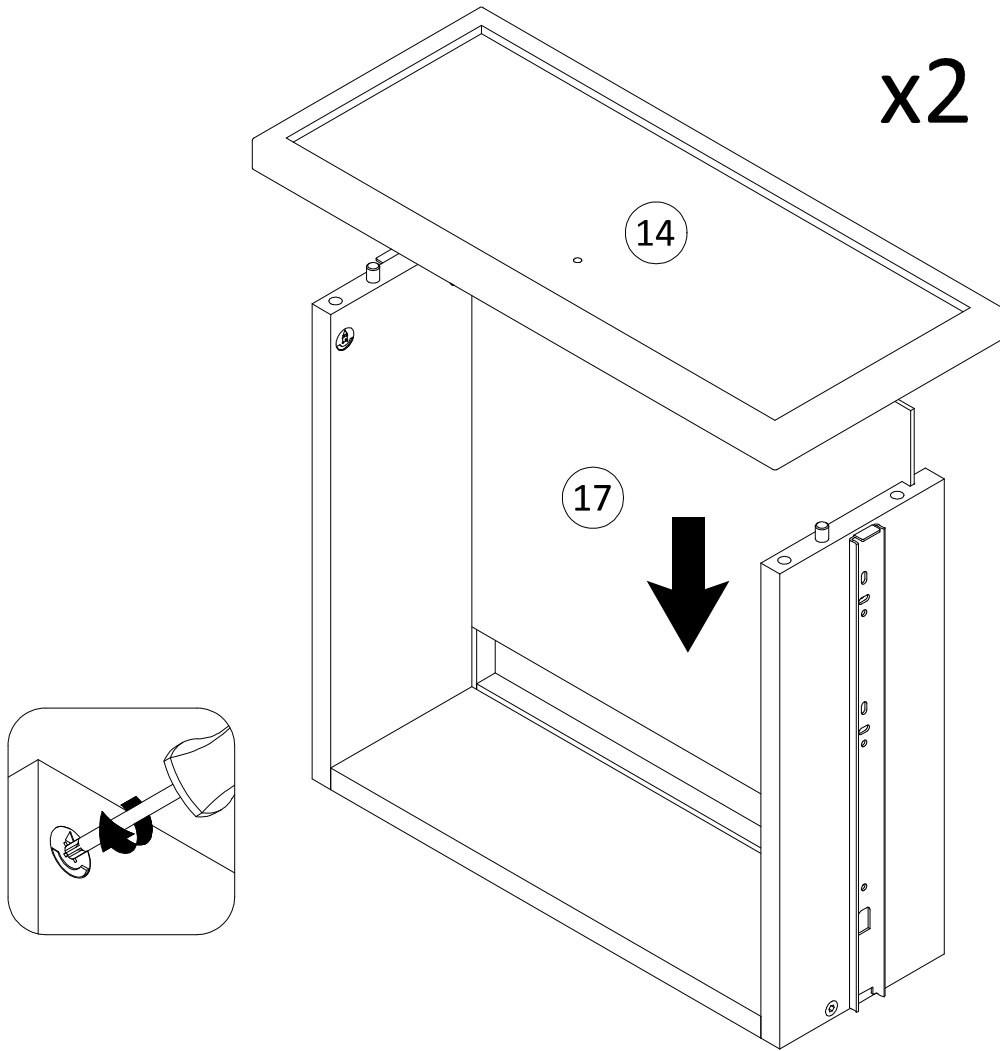

20

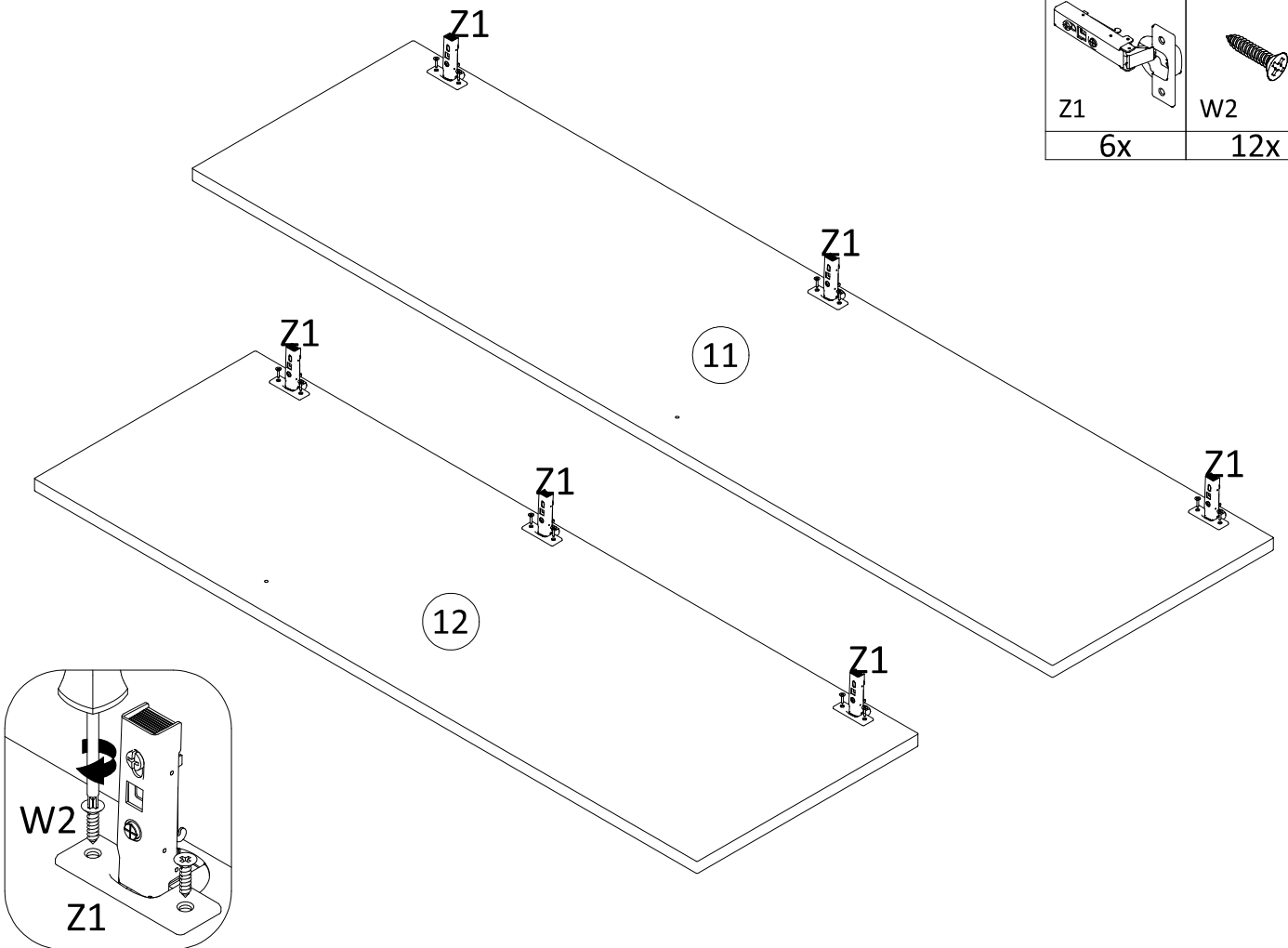

# 21

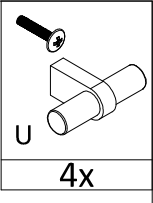
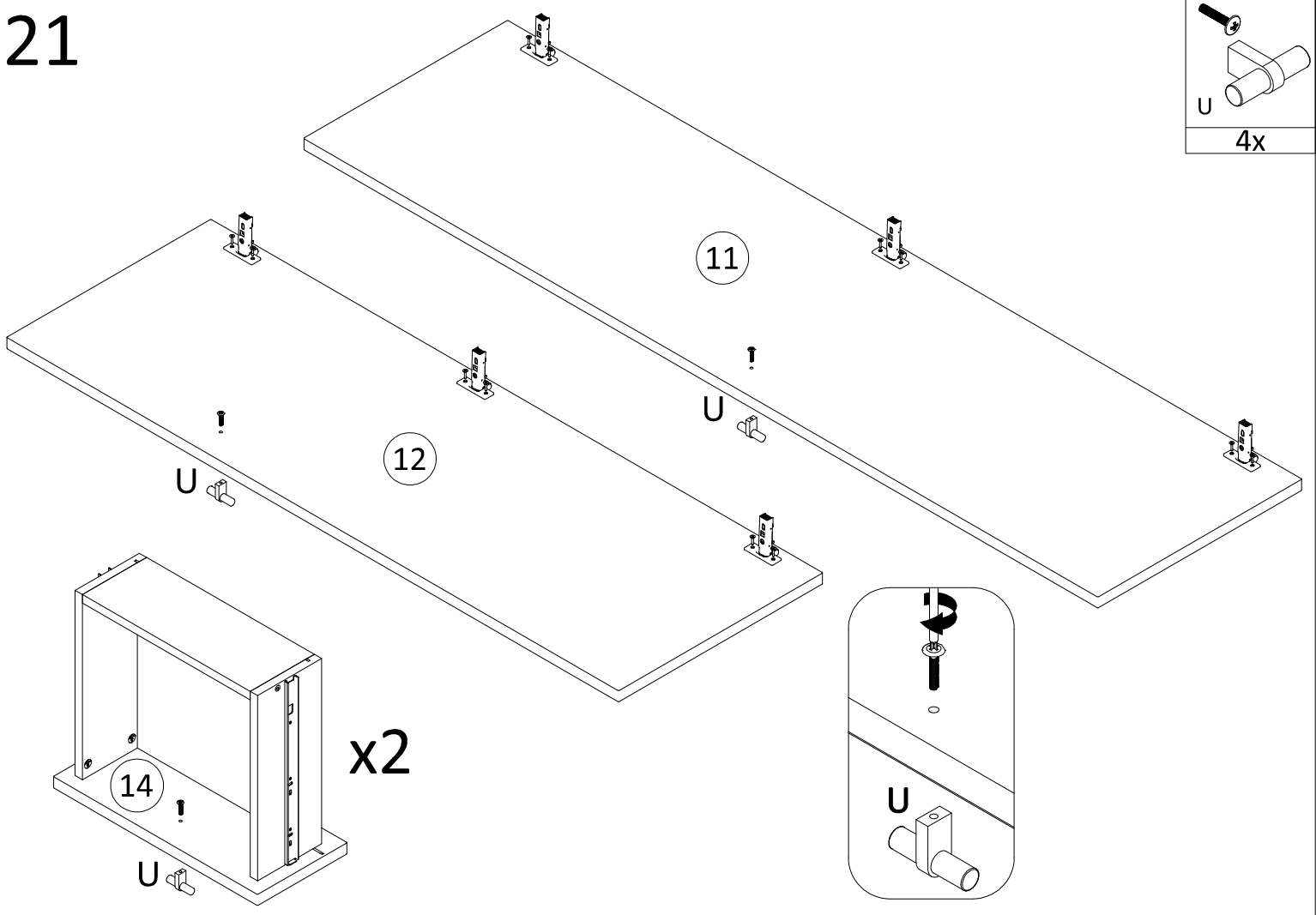

# 22

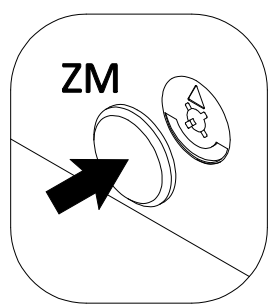
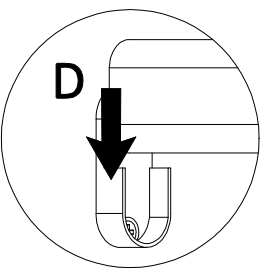
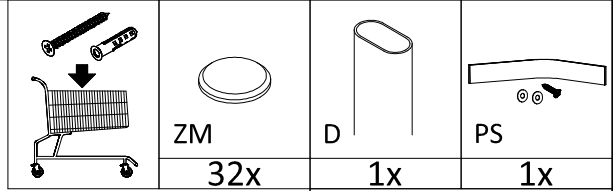
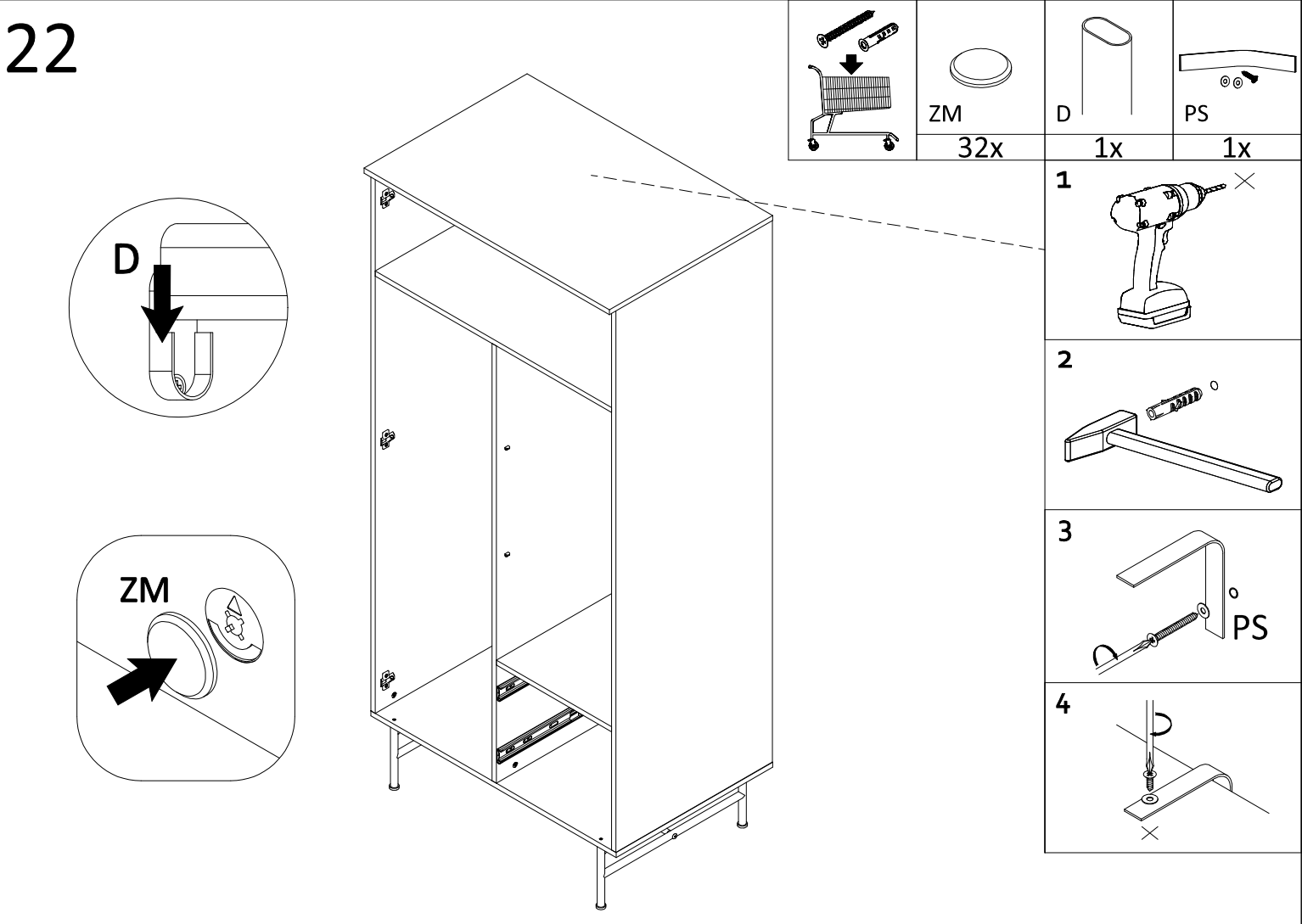

- 1
- 2
- 3
- 4

# 23

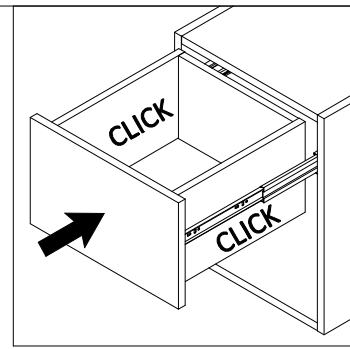
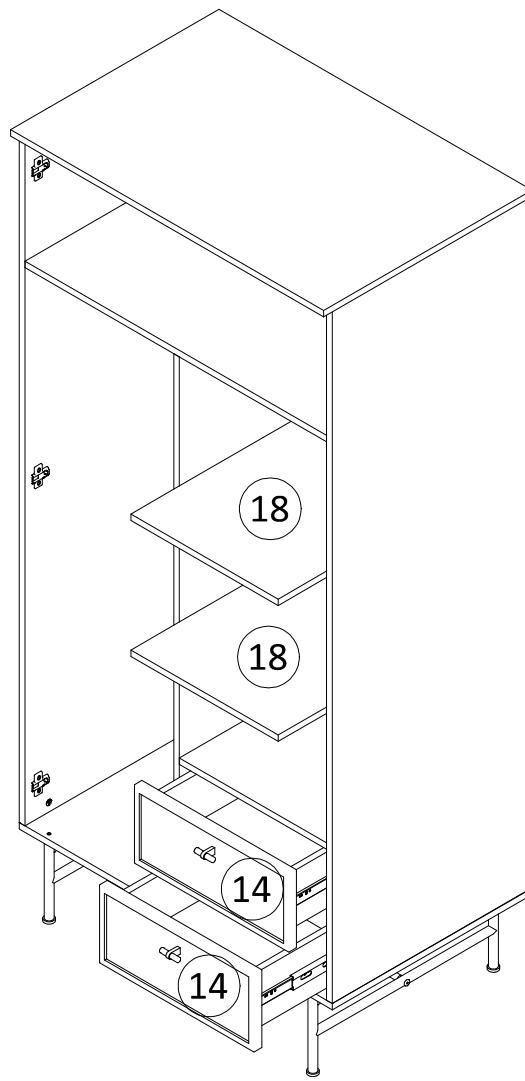
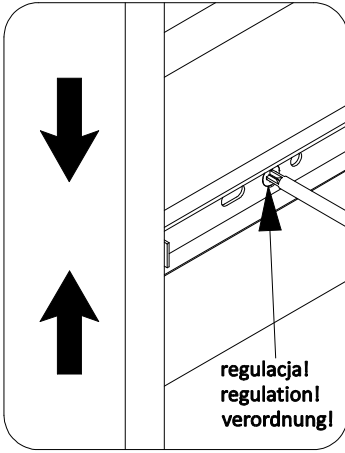

# 24

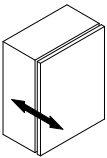
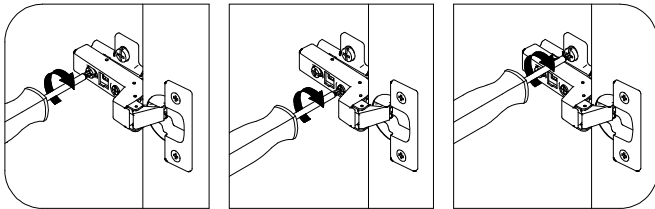

±2mm

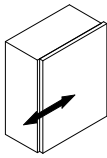

±2mm

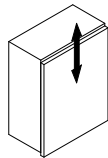

±2mm

